

MONTAGEANLEITUNG

ASSEMBLY INSTRUCTION

NOTICE DE MONTAGE

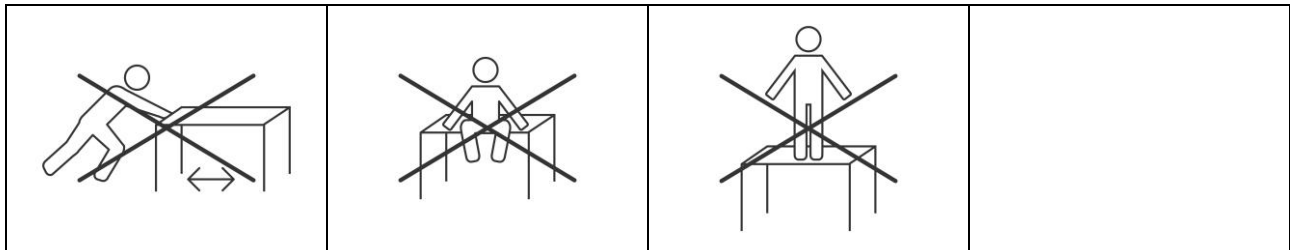

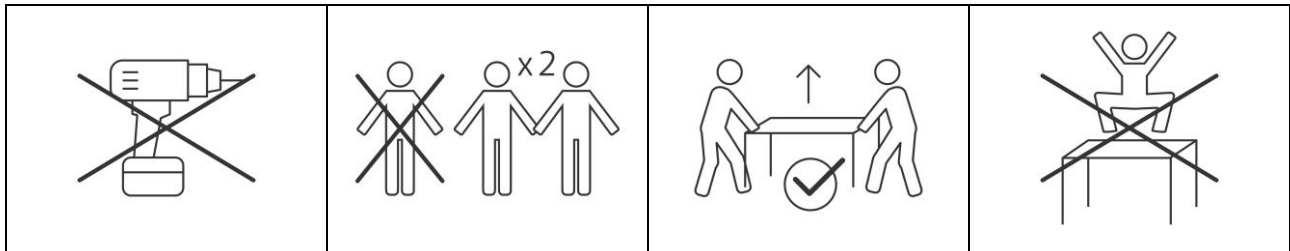





A 2 x	B 1 x	C 2 x M12 x 62	D 2 x

E 4 x	F 4 x Ø 30 mm	G 4 x M12	H & M 1 x

Dieser Montageschritt gilt nur für Silverstar-Tischplatten /// This assembly step only applies for Silverstar table tops /// Cette étape de montage ne s'applique qu'aux plateaux de table Silverstar



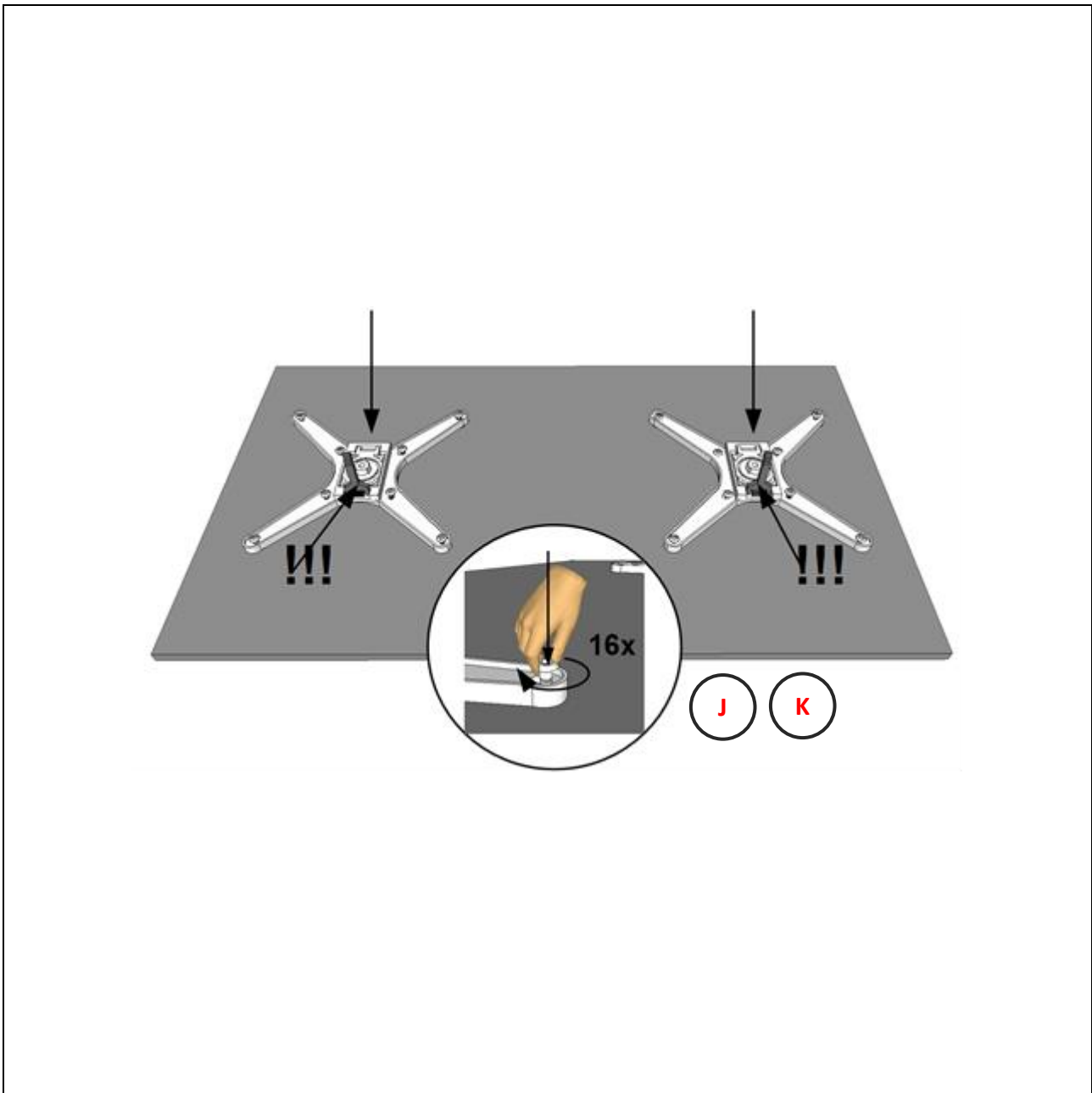

I 1 x	J 16 x M5 x 16	K 16 x Ø 12 mm	L 1 x

1.

A 2 x	I 1 x	J 16 x	K 16 x		
					



2.

C 2x	E 2x	F 2x	G 2x		
					

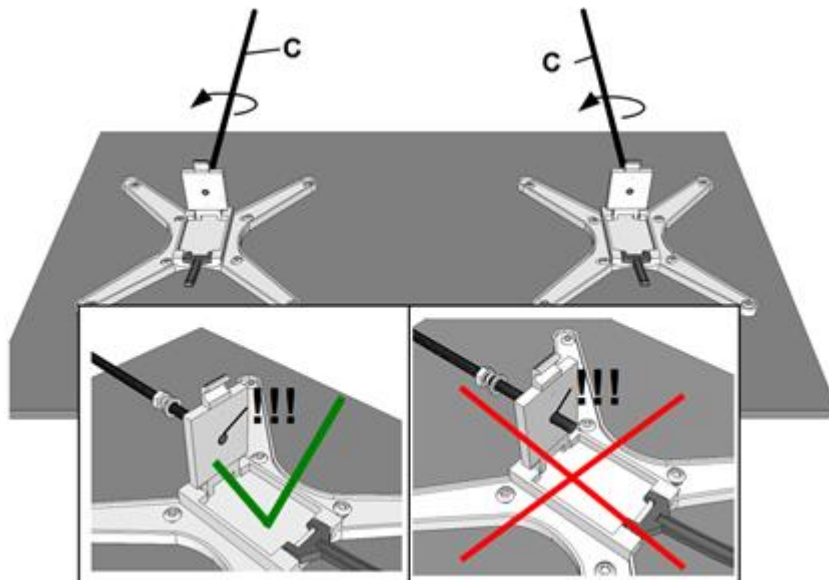
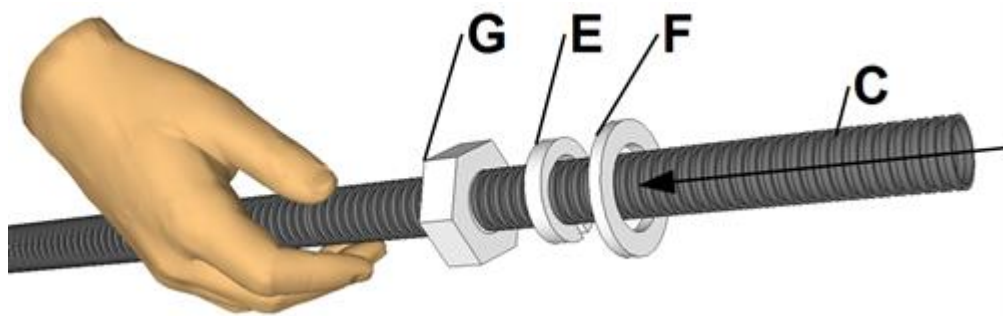

3.

H 1 x					
					

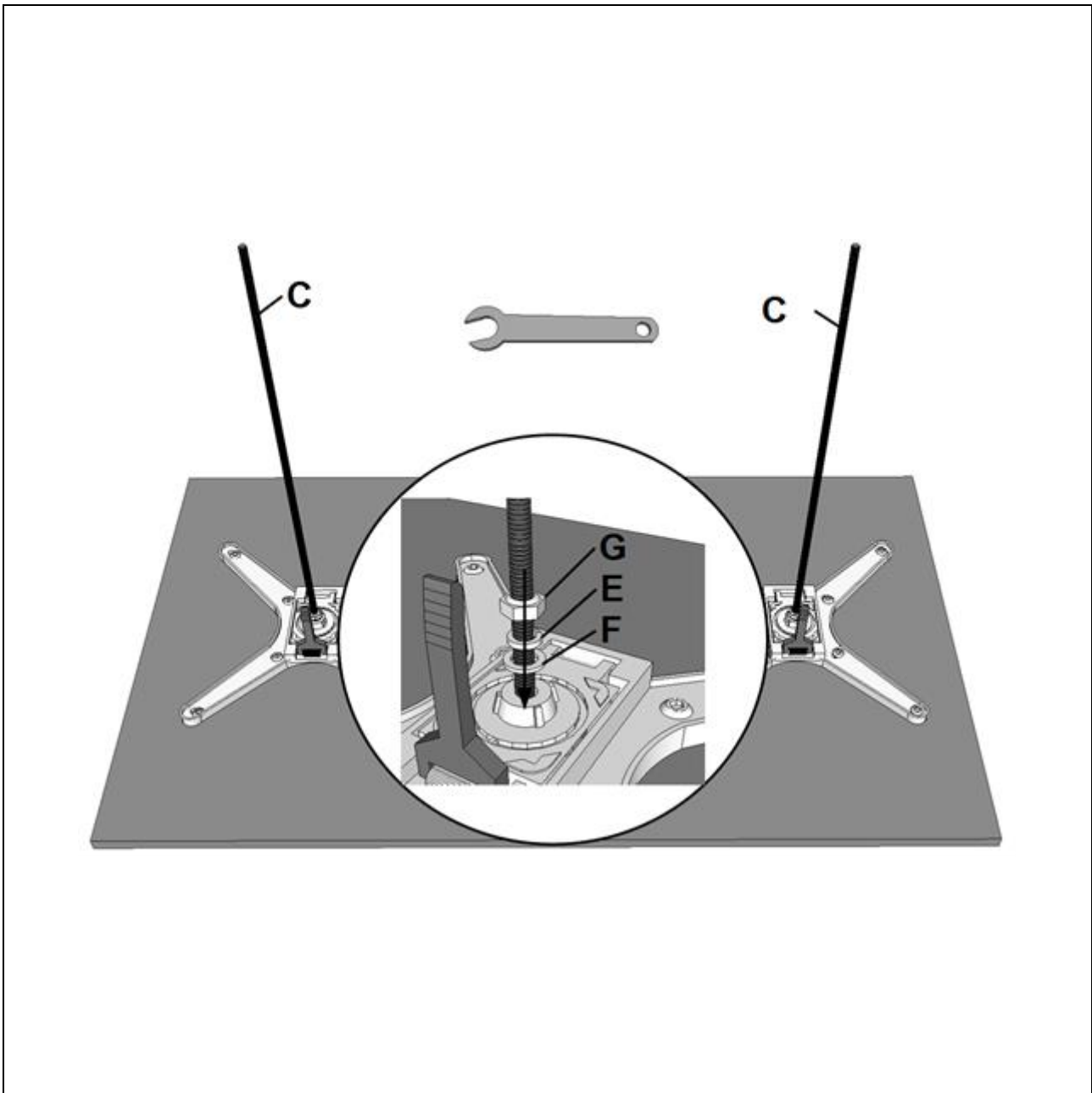



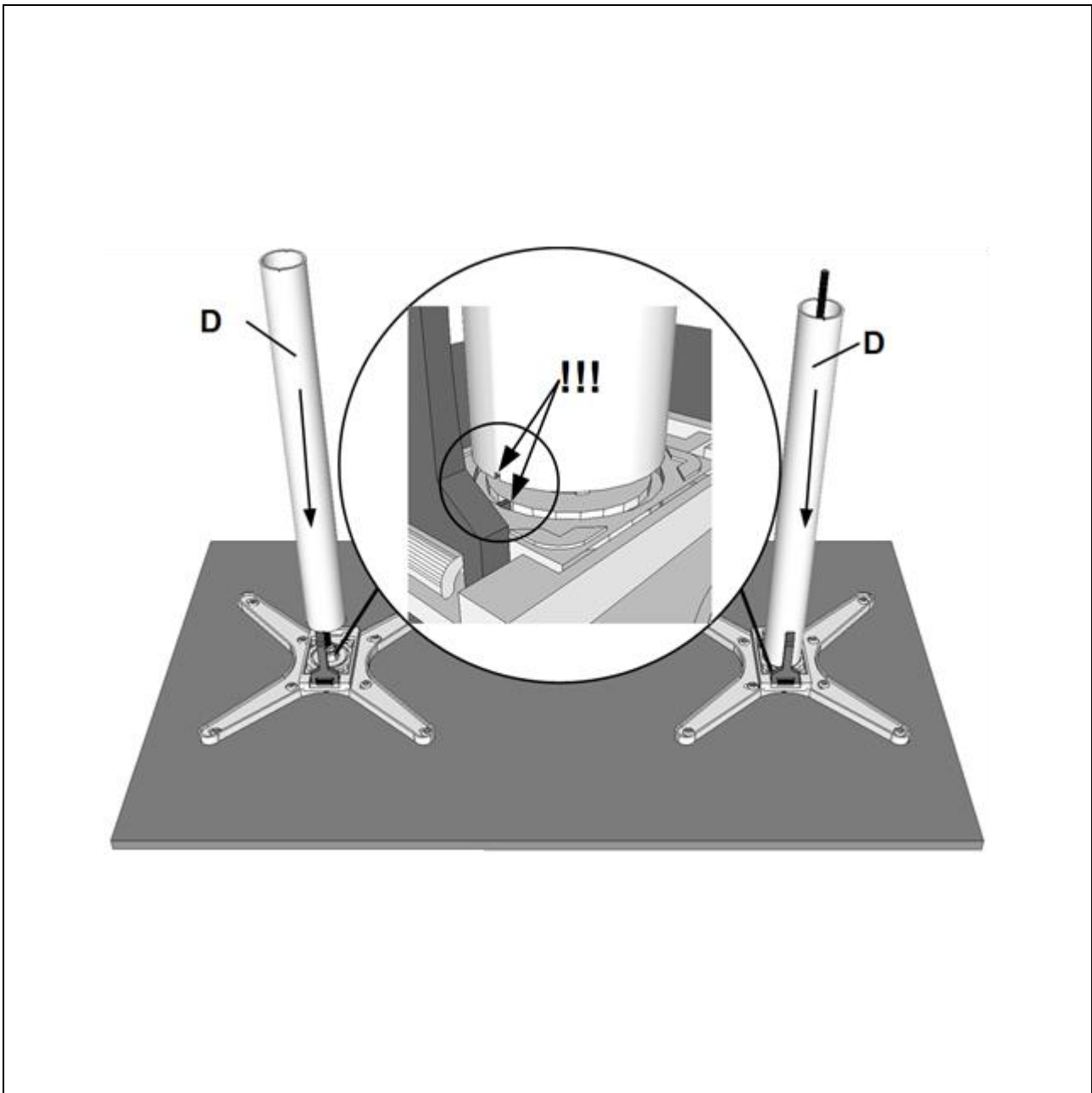

4.

D 2 x					
					



5.

B 1 x	E 2 x	F 2 x	G 2 x	M 1 x	
					

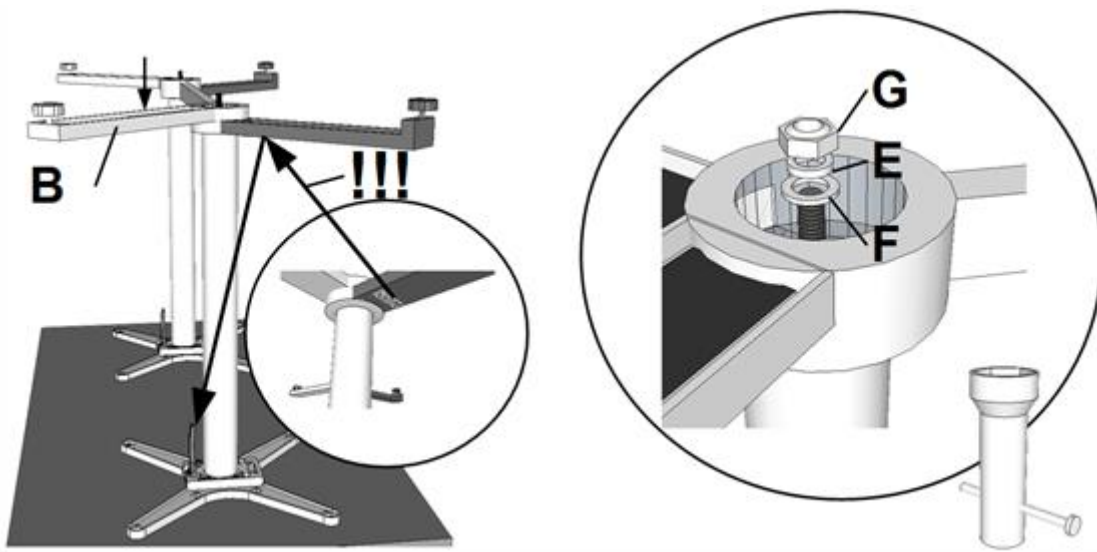

Der Hebel der Abklappmechanik muss auf der gleichen Seite sein, wie das niedrigere Beinprofil
 The lever of the folding mechanism must be on the same side as the lower leg profile
 Le levier du mécanisme de pliage doit être positionné du côté où les pieds sont les plus bas



6.

L | 1x

