

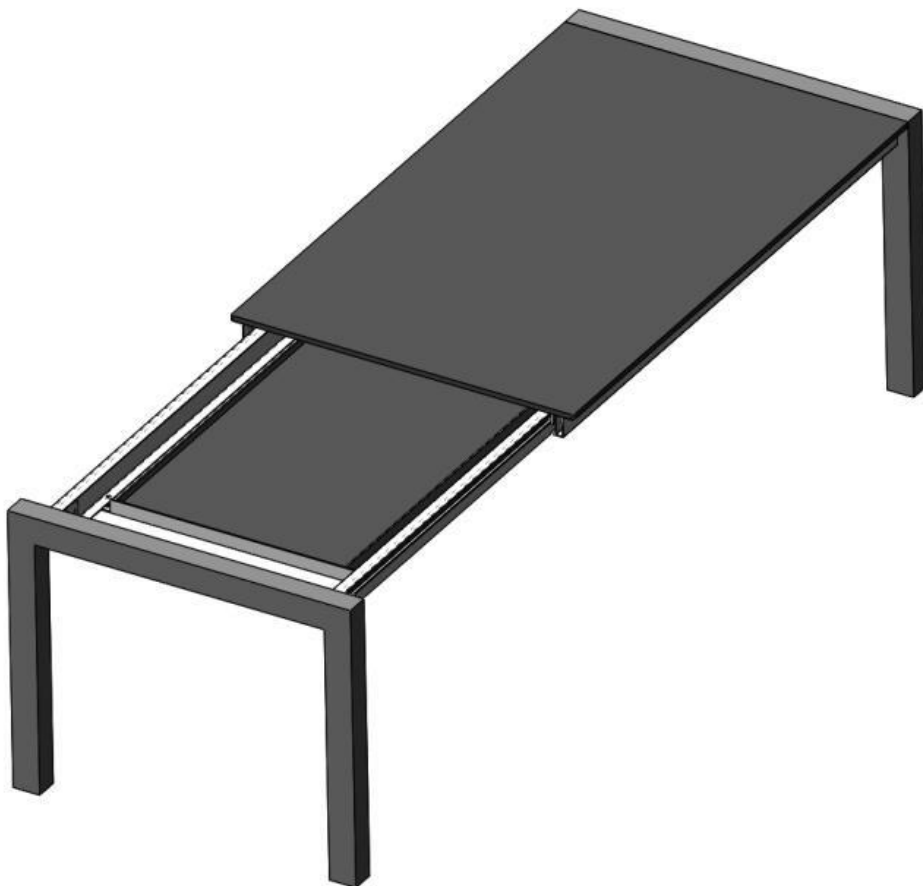

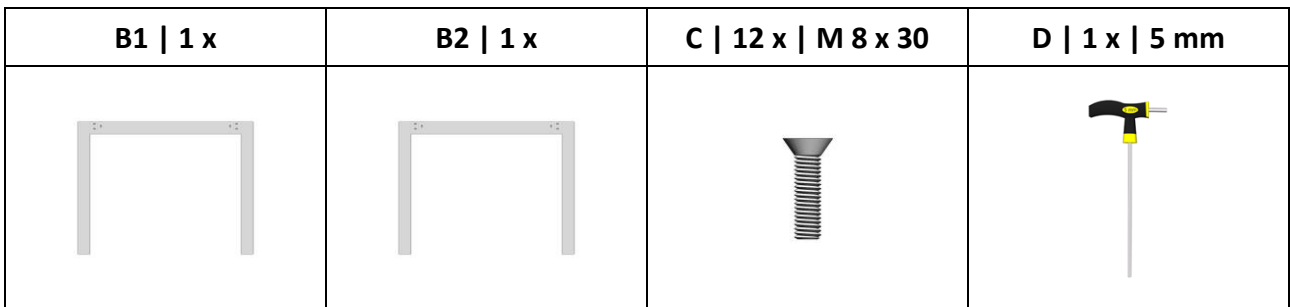

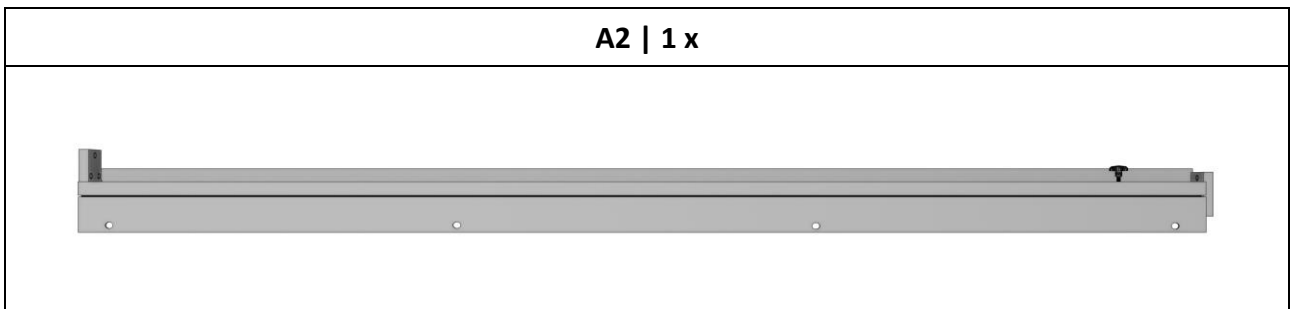

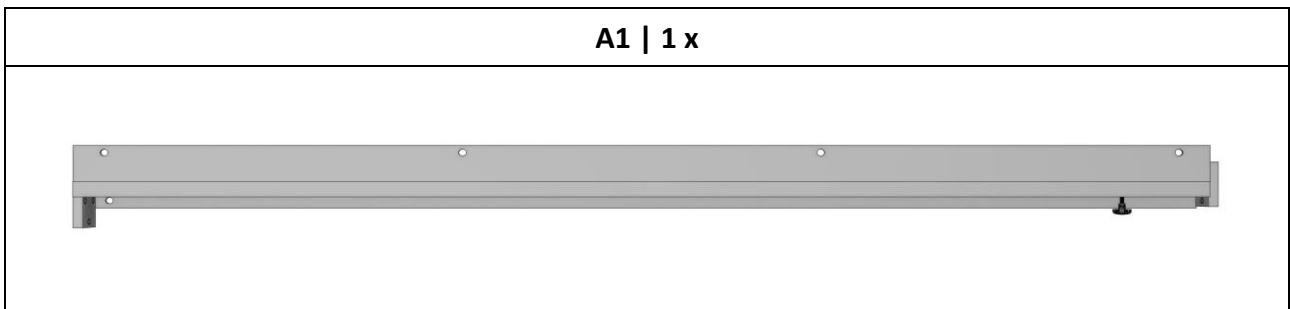

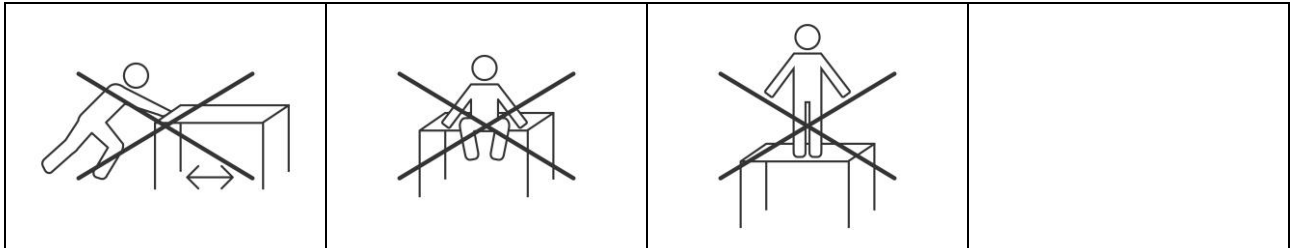
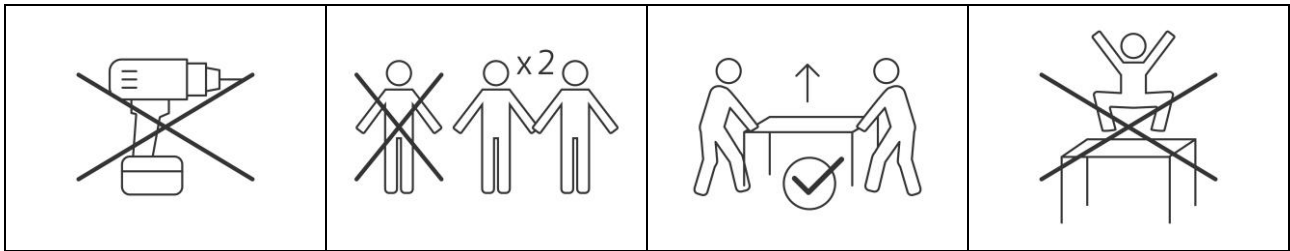





MONTAGEANLEITUNG

ASSEMBLY INSTRUCTION





NOTICE DE MONTAGE

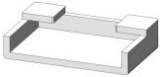



E 2 x	F 4 x M 6 x 16	G 4 x	H 4 x M 6 x 15,5
			
I 1 x 4 mm	J 2 x	K 4 x M 6 x 12	L 4 x M 6
			
M 1 x	N 8 x M 5 x 12	O 8 x Ø 12 mm	P1 2 x 40 cm
			 SILVERSTAR
P2 1 x 60 cm	Q 4 x		
 DEKTON			

1.

A1 1 x	A2 1 x	B1 1 x	B2 1 x
			

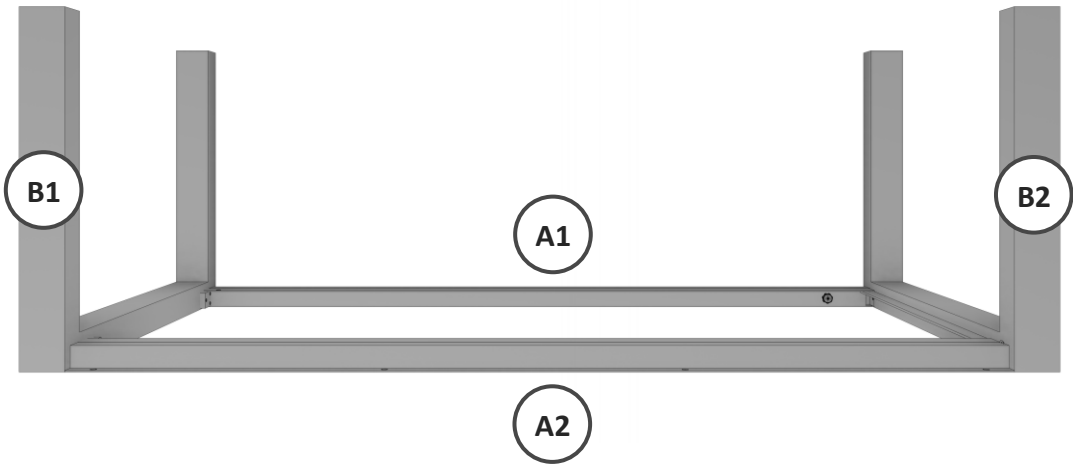

Der Aufbau sollte auf einem ebenen und weichen Untergrund erfolgen
Verwenden Sie beispielsweise das Verpackungsmaterial zum Schutz vor Beschädigungen

The setup should be done on an even and soft floor
For example, use the carton packing material in order to avoid any damages

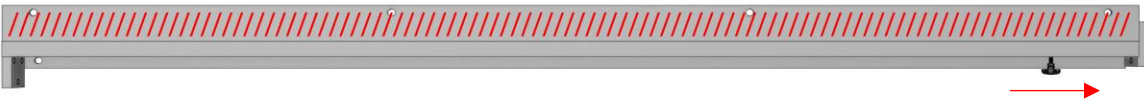

L'installation doit être effectuée sur un sol plat et protégé
Par exemple utilisez le carton d'emballage pour éviter des endommagements



Auszug mit dieser Fläche nach unten auf den Boden legen
Place the pullout on the floor with this surface facing downwards
Placez les glissières avec les 4 trous de fixation du plateau contre le sol

Die Verstellerschrauben zeigen immer nach rechts
The adjustment screws always point to the right
Les vis de réglage sont toujours orientées vers la droite

2.

C 12 x	D 1 x				
					

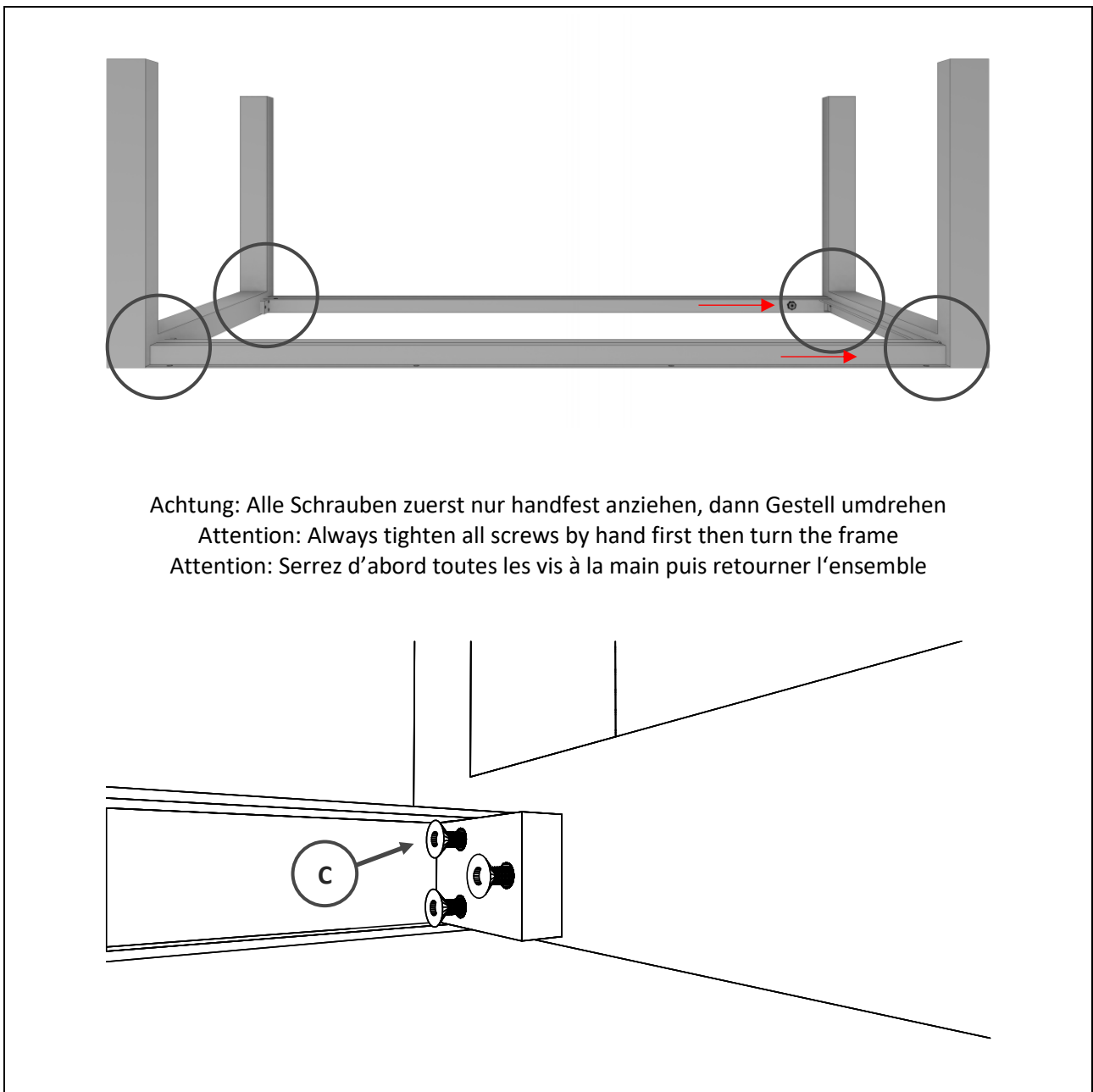

3.

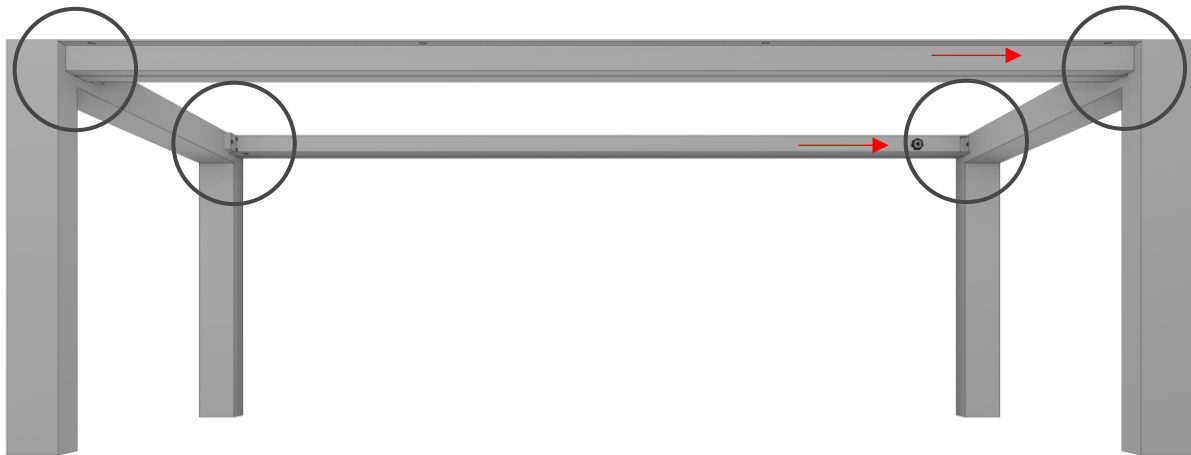





Ausziehtisch komplett zusammenschieben und alle zugänglichen Schrauben fest anziehen,
dann etwas auseinander ziehen und die restlichen Schrauben fest anziehen

Pull in the extension table completely and tighten all accessible screws
Then extend the table a little bit and tighten the remaining screws



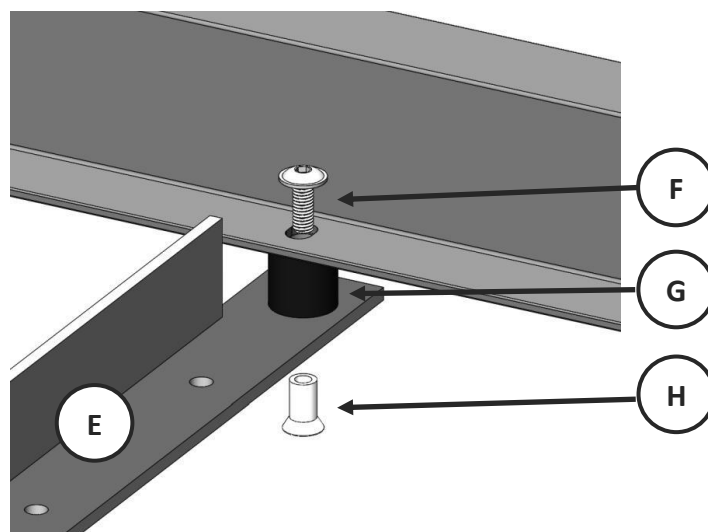
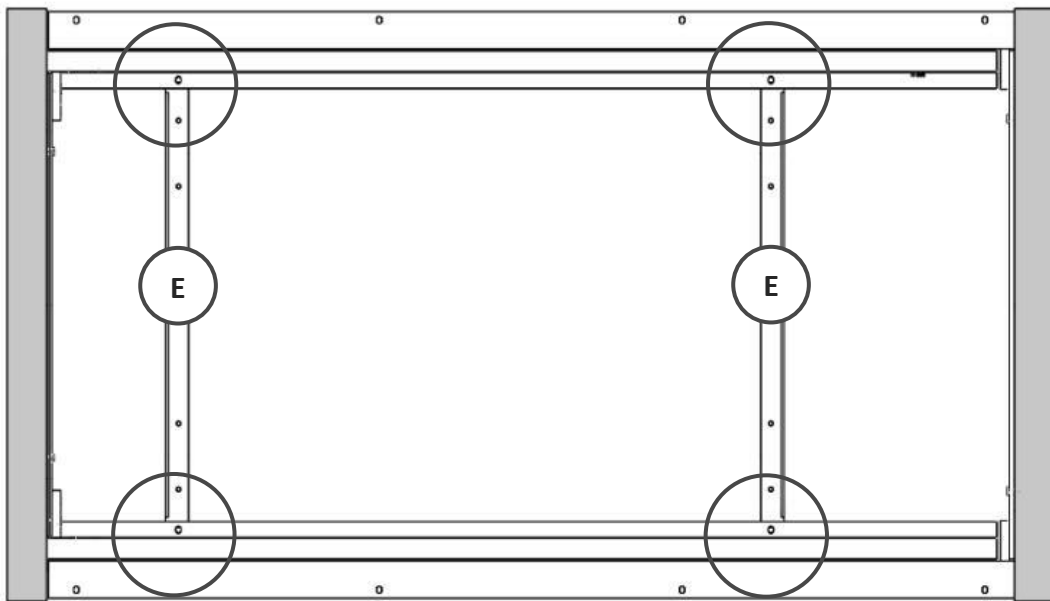

Rentrez complètement les glissières et serrez toutes les vis qui sont accessibles
puis laissez environ 30 cm d'ouverture et serrez les autres vis

4.

E 2 x	F 4 x	G 4 x	H 4 x	I 1 x	
					



5.

J 2 x	K 4 x	L 4 x	I 1 x		
					

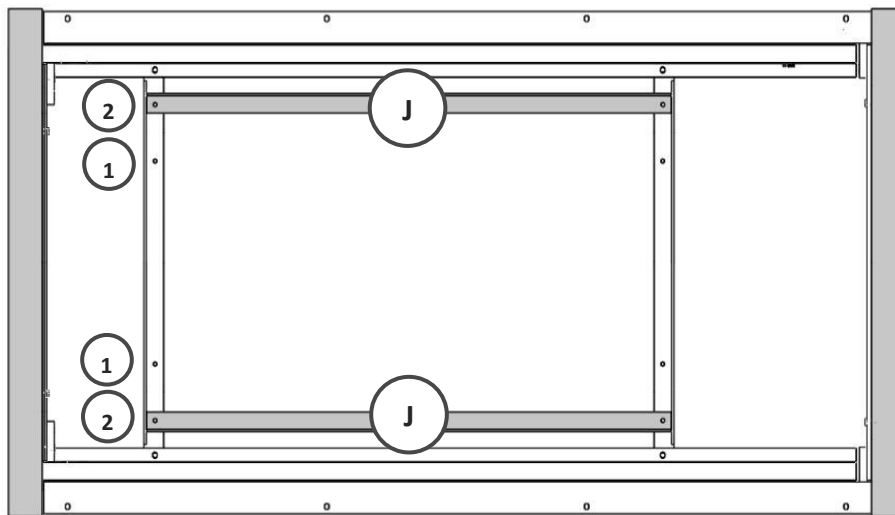



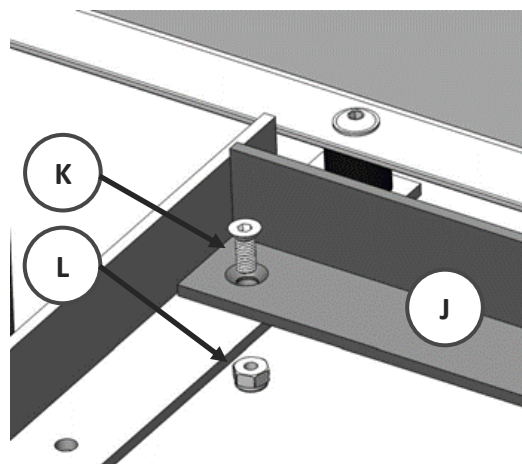

Position ①: SILVERSTAR Einlegeplatte/extension top/rallonge

Position ②: DEKTON Einlegeplatte/extension top/rallonge



6.

M 1 x	N 8 x	O 8 x	I 1 x		
					

MONTAGE/ASSEMBLY/MONTAGE SILVERSTAR

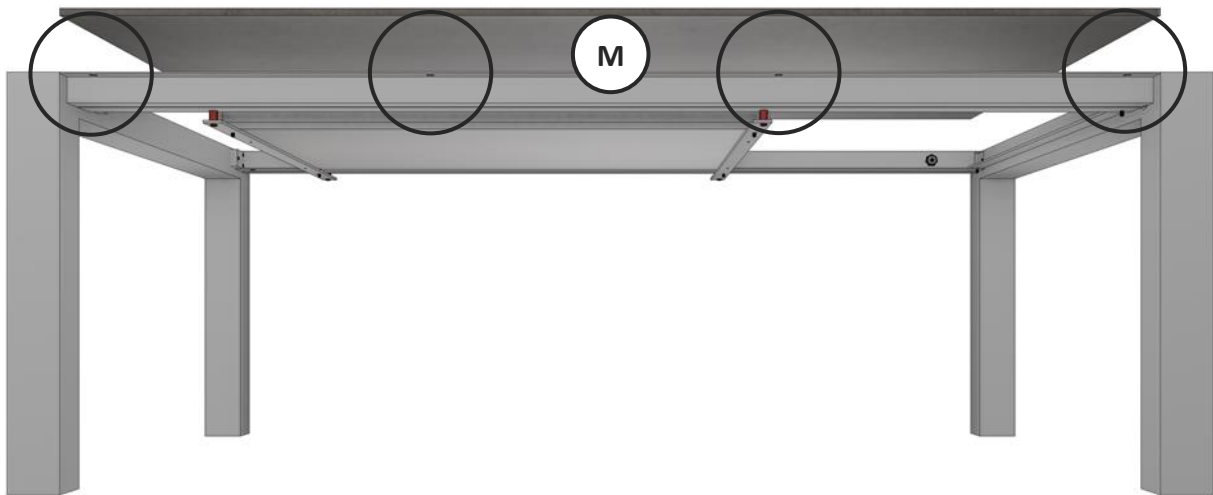

Platte auf den Tischrahmen legen, ausrichten und mit den Auszügen verschrauben
Place the plate on the table frame, align it and screw it with the guide rails
Placez le plateau sur le cadre de la table, alignez-le puis vissez le avec les glissières

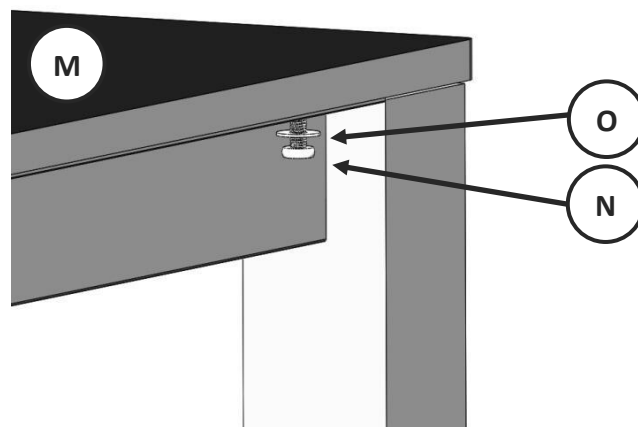

7.	
----	--

P1 2 x					
					

MONTAGE/ASSEMBLY/MONTAGE SILVERSTAR



Einlegeplatten wie abgebildet verstauen

Stow Extension tops as shown

Ranger les rallonges comme indiqué



8.	
----	--

M 1 x					
					

MONTAGE/ASSEMBLY/MONTAGE DEKTON

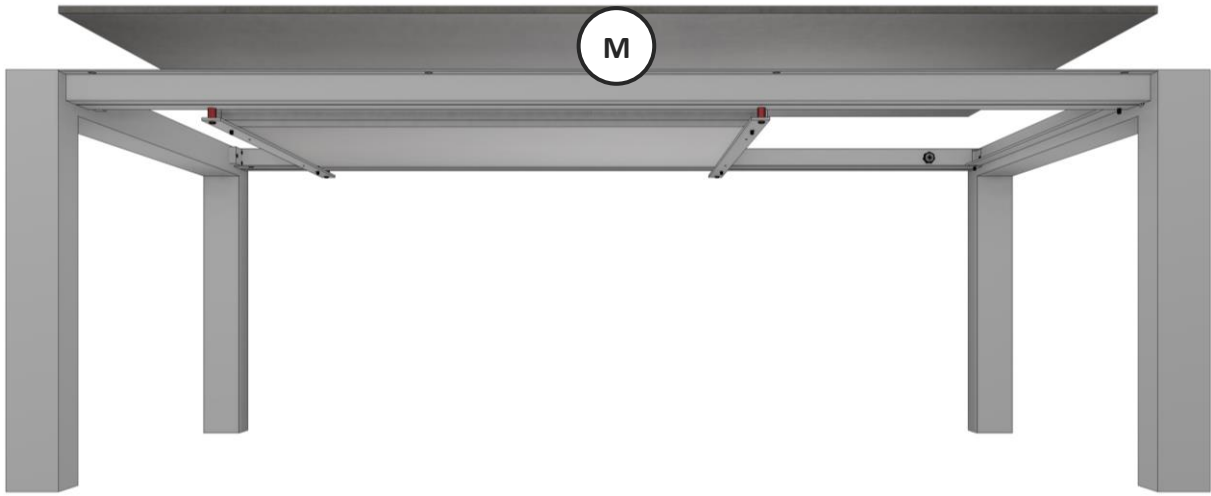

Nur für Dektonplatten – diese werden nur aufgelegt und nicht verschraubt!
 Only for Dekton plates - these are only put on and not screwed!
 Uniquement pour le Dekton - ces éléments sont uniquement posés et non vissés!



Achtung vormontierte Antirutschbänder nicht entfernen
 Attention do not remove pre-assembled anti-slip strips
 Attention Ne pas retirer les bandes antidérapantes prémontées

9.

P2 1 x					
					

MONTAGE/ASSEMBLY/MONTAGE DEKTON



Einlegeplatte wie abgebildet verstauen

Stow Extension top as shown

Rangez la rallonge comme indiqué

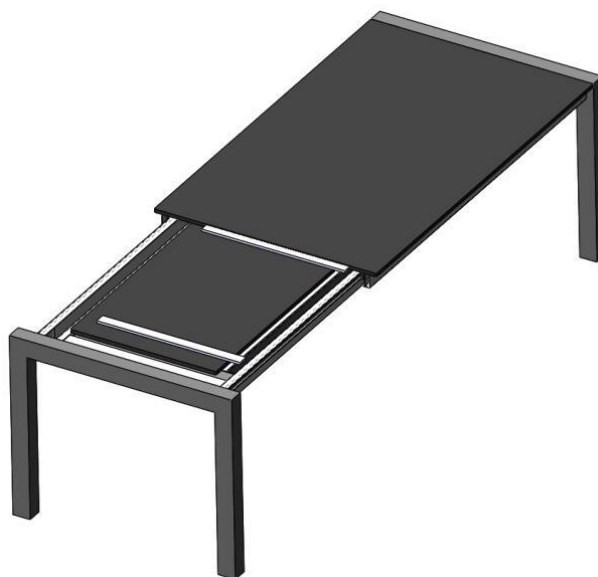

10.

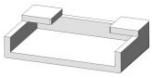
Q 4 x					
					

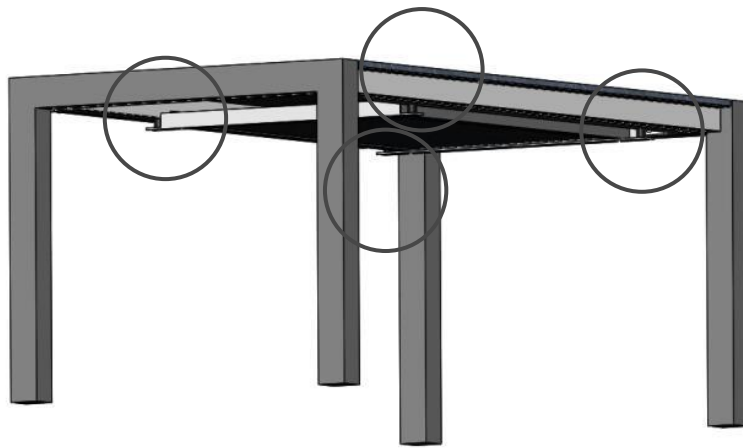

Jeweils auf beiden Seiten anbringen.
To be applied on both sides.
Appliquez des deux côtés.

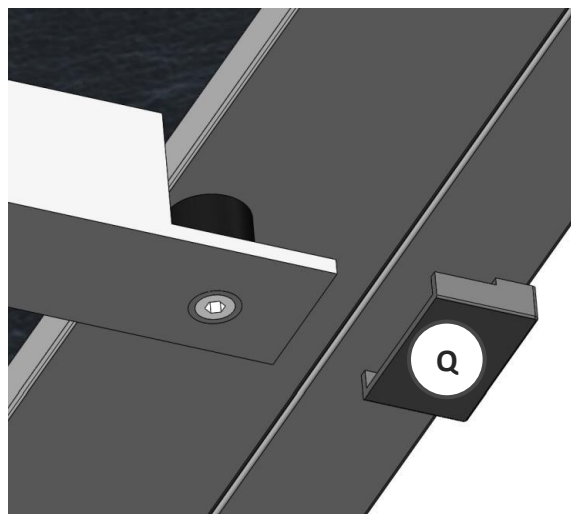

11.

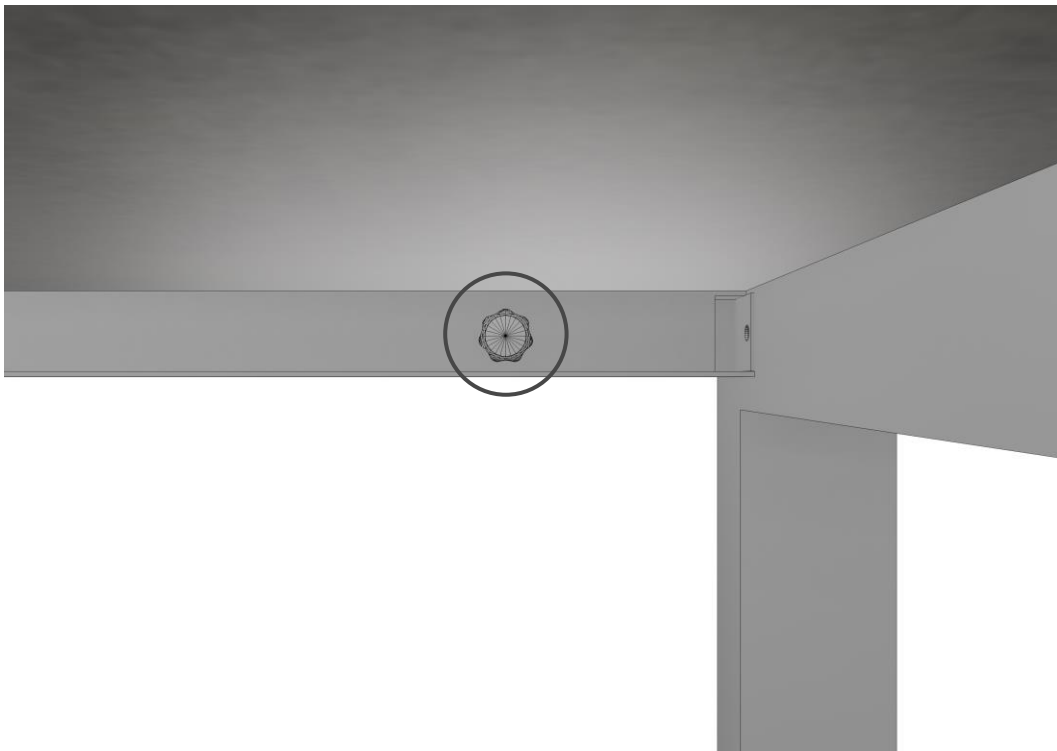

Achtung Feststellschrauben – vor dem Auseinanderziehen und Zusammenschieben bitte lösen

Attention Locking screws – please loosen before extending and pushing together

Attention vis de verrouillage – veuillez desserrer avant de faire coulisser la table

12.

Bei Bedarf können die auf der ausziehbaren Seite werkseitig vormontierten Rollen gegen Höhenversteller ausgetauscht werden

If necessary, the wheels pre-mounted at the factory on the extendable side can be exchanged for height adjusters

Si nécessaire, les roulettes pré-montées en usine sur le côté mobile peuvent être remplacées par des sur-élévateurs (sols non réguliers)



Höhenversteller
height adjuster
sur-élévateur

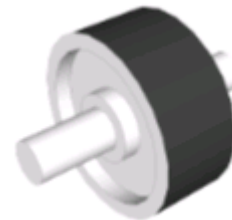

Rolle
wheel
roulette

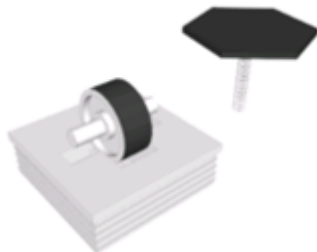

Rolle herausnehmen
remove the wheel
Retirer la roulette



Höhenversteller eindrehen
Screw in height adjuster
Ajuster le sur-élévateur